

Actual information about approvals can be found on <http://www.schurter.com/approvals>



C20  
  
 70° C



Standard- or Medical-Filter

**Description**

- Panel mount:  
Screw-on version from front side
- 3 Functions:  
Connector Protection class I, circuit breaker type TA45 2-pole, Line filter in standard and medical version
- Quick connect terminals 6.3 x 0.8 mm
- Alternative: version without line filter EF11 see page 42

**Characteristics**

- All single elements are already wired
- Line switch non-illuminated  
Illuminated version on request
- Thermal overload protection  
Optional with undervoltage release or remote trip release
- With EMC-shield
- Qualified for use in equipment according IEC/EN 60950

**Technical data**

Ratings IEC	10 - 16 A @ Ta 40 °C / 250 VAC; 50 Hz
Ratings UL/CSA	10 - 20 A @ Ta 40 °C / 125 VAC; 60 Hz
Leakage current	standard < 0.5 mA (250 V / 60 Hz) medical < 5 µA (250 V / 60 Hz)
Dielectric strength	> 1.7 kVDC between L-N > 2.7 kVDC between L/N-PE Test voltage (2 sec)
Allowable operation temp.	-10 °C to 55 °C
Climatic category	10/055/21, IEC 60068-1
Degree of protection	from front side IP40 acc. to IEC 60529
Protection class	Suitable for appliances with protection class I acc. to IEC 61140
Terminals	Quick connect terminals 6.3 x 0.8 mm
Panel thickness s	Screw-on: max 8 mm Mounting screw torque max 0.5 Nm
Materials: Housing	Thermoplastic, black, UL 94V-0

Appliance-inlet /-outlet	C20 acc. to IEC/EN 60320-1, UL 498, CSA C22.2 no. 42 (for cold condition) pin-temperature 70 °C, 16 A, Protection class I
Circuit breaker	Acc. IEC/EN 60934, UL 1077, CSA 22.2 no. 235 2-pole rocker switch, illuminated or non-illuminated. Optional with undervoltage- or remote trip release Short circuit capacity Icn: at In < 3A/240VAC: 10 x In at In ≥ 3A/240VAC: 300A
Line filter	Standard and medical version, IEC 60939, IEC 60601-1, UL 1283, UL 544, EN 133 200, CSA C22.2 no. 8 Technical details see page 290

Dimensions

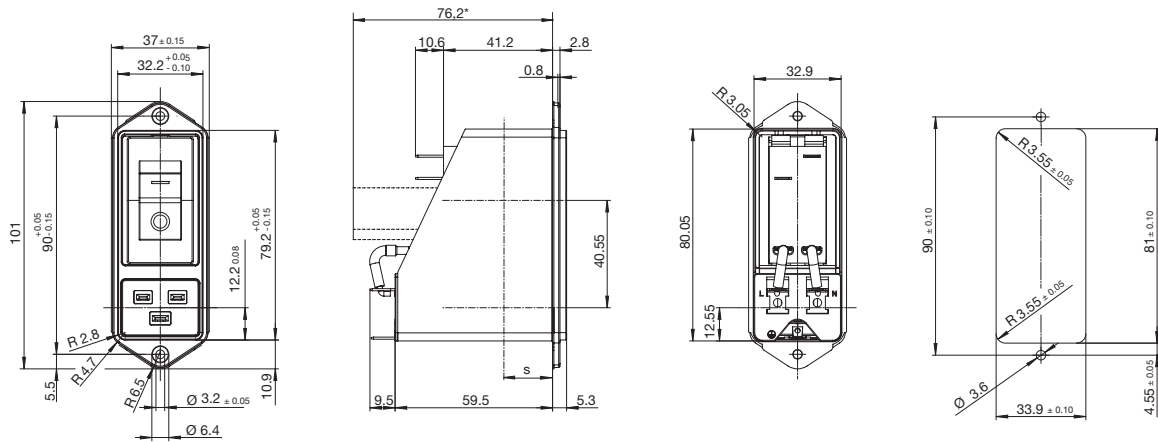

\* --- Version TA45 with undervoltage release

Technical data of filter-components

Rated current [A]	Filter-Type	Inductances		Capacitance		R [M $\Omega$ ]
		L [mH]	CX [nF]	CY [nF]		
12	Standard Version	2 x 0.8	100	2.2	1	
16	Standard Version	2 x 0.6	100	2.2	1	
20	Standard Version	2 x 0.3	100	2.2	1	
12	Medical Version (M5)	2 x 0.8	100		1	
16	Medical Version (M5)	2 x 0.6	100		1	
20	Medical Version (M5)	2 x 0.3	100		1	

Diagrams

Standard version

Medical version

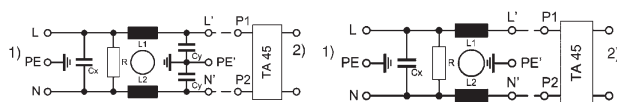

1) Line  
2) Load

1) Line  
2) Load

Attenuation loss

--- differential mode    — common mode

Standard version

12 A

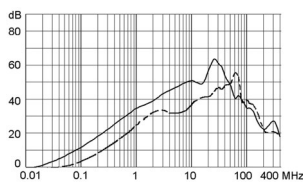

16 A

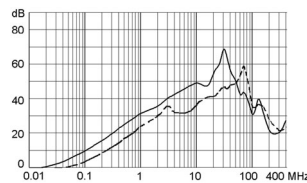

20 A

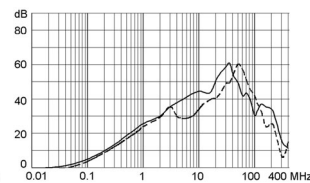

Medical version  
12 A

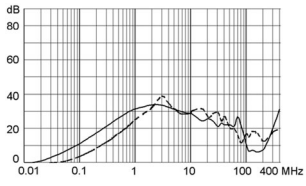

16 A

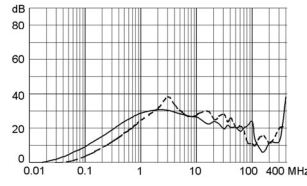

20 A

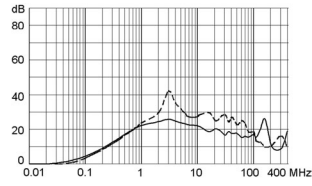

Packaging unit 20 Pcs

**Table 1 Selection for type TA45**

Order example

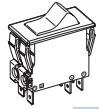

- Line switch
  - 2-pole, rocker actuated
  - Quick connect terminal
- Other types on request

**ABT W F 150 C0**

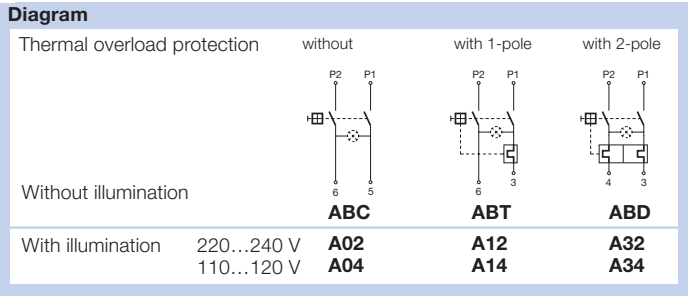

**Colours**

Switch front	Rocker
<b>W</b> black	white
<b>B</b> black	black
<b>6</b> black	—
	orange transp.

**Rocker legend**

Surface	Illustration	Colour of print
<b>F</b> embossed		—
<b>H</b> printed		white
<b>K</b> printed		black
<b>L</b> printed		white

Surface	Illustration	Colour of print
<b>M</b> printed		black
<b>P</b> printed		white
<b>R</b> printed		black

Position of the rocker legend e.g F

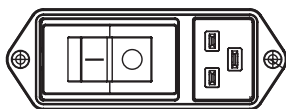

**Rated current:**

- Without thermal overload protection: code C00 }  $I_n = 20\text{ A}$
- With thermal overload protection: rated current  $I_n$  (A)

$I_n$	Code	$I_n$	Code	$I_n$	Code	$I_n$	Code
10,0	<b>100</b>	13,0	<b>130</b>	16,0	<b>160</b>	19,0	<b>190</b>
11,0	<b>110</b>	14,0	<b>140</b>	17,0	<b>170</b>	20,0	<b>200</b>
12,0	<b>120</b>	15,0	<b>150</b>	18,0	<b>180</b>		

**Without release: code C0**

Undervoltage release			Remote trip release		Rated voltage $U_n$
<b>U</b>	<b>E</b>	<b>Z</b>	<b>A</b>	Code	
•	•	•	•	<b>2</b>	240 V AC
•	•	•	•	<b>3</b>	230 V AC
•	•	•	•	<b>4</b>	120 V AC

**Circuit breaker**

Tripping characteristics

$I_n < 3 A$

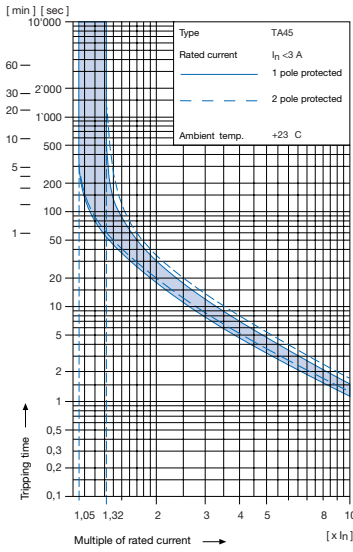

Tripping characteristics

$I_n 3... < 18 A$

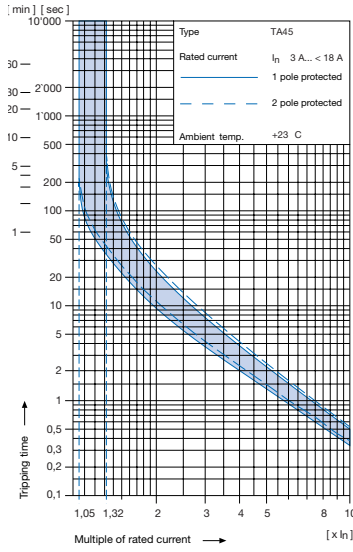

Tripping characteristics

$I_n 18 A$

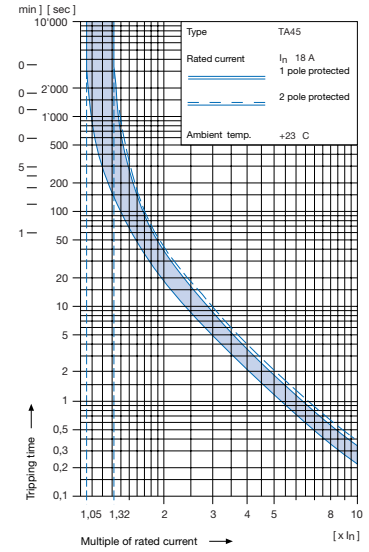

**1) Effect of ambient temperature**

The unit is calibrated for an ambient temperature of +23 °C. To determine the rated current for a lower or higher ambient temperature, use a correction factor from the table on the right side:

Ambient temperature [°C]	Correction factor
-10	0,89
-5	0,91
0	0,92
+23	1,00
+30	1,03
+40	1,08
+55	1,16

\* Temperature must be measured at the rear of the breaker next to the terminals after equipment operating temperature has been reached.

**1) Example**

Rated current at +23 °C 6,0 A  
 Ambient temperature +40 °C  
 Correction factor 1,08  
 Chosen rated current at +40 °C ambient temperature **6 A x 1,08 = 6,5 A**

**Order code for EF12 (order example)**

<b>Type</b>	<b>Order code TA45</b> (2-pole rocker-switch without accessories)
<b>EF12.</b>	<b>A B T W F 1 5 0 C 0 .</b>
	see table 1

- 11 10.01**
- Wiring**  
1 = wired
- Protection class**  
0 = Class I, housing black
- Panel mount**  
0 = Screw-on version
- Terminals**  
1 = Quick connect terminals 6,3 x 0,8 mm
- Line filter version**  
1 = standard  
2 = medical
- Line filter, rated current**  
1 = 20 A, 2 = 16 A, 3 = 12 A

Please note that Schurter will establish an internal new part number for logistical use in addition to the order code. The format of this internal part number is, for example EF12.xxxx.1110.01

**Application note**

The rated current of the line filter must be equal or higher than the rated current of the circuit-breaker

**Other versions on request**

- Rocker switch illuminated